

1 Isometric - Detail Map - Tactile FRP™  
 AM-00 Scale: No Scale

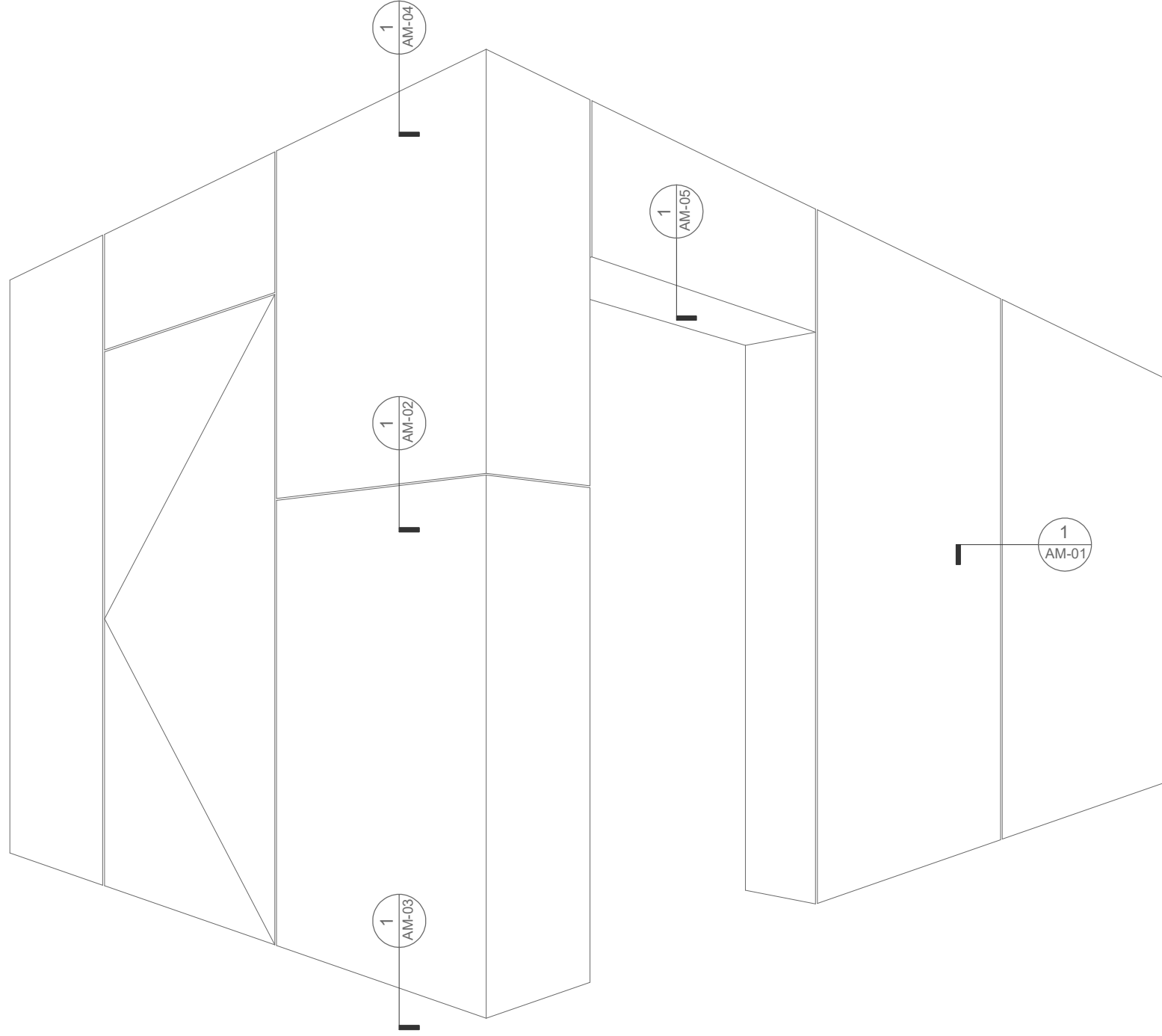

SHEET NO. AM-00	REVISIONS	PROJECT#	ARCHITECT	CLIENT
SCALE AS NOTED	DESCRIPTION	Tactile FRP™ Cladding Details Ventilated Rainscreen		
DRAWN BY JO	DATE			
APPROVED BY SE	APPROVED			
ISSUE DATE 11/05/2019				

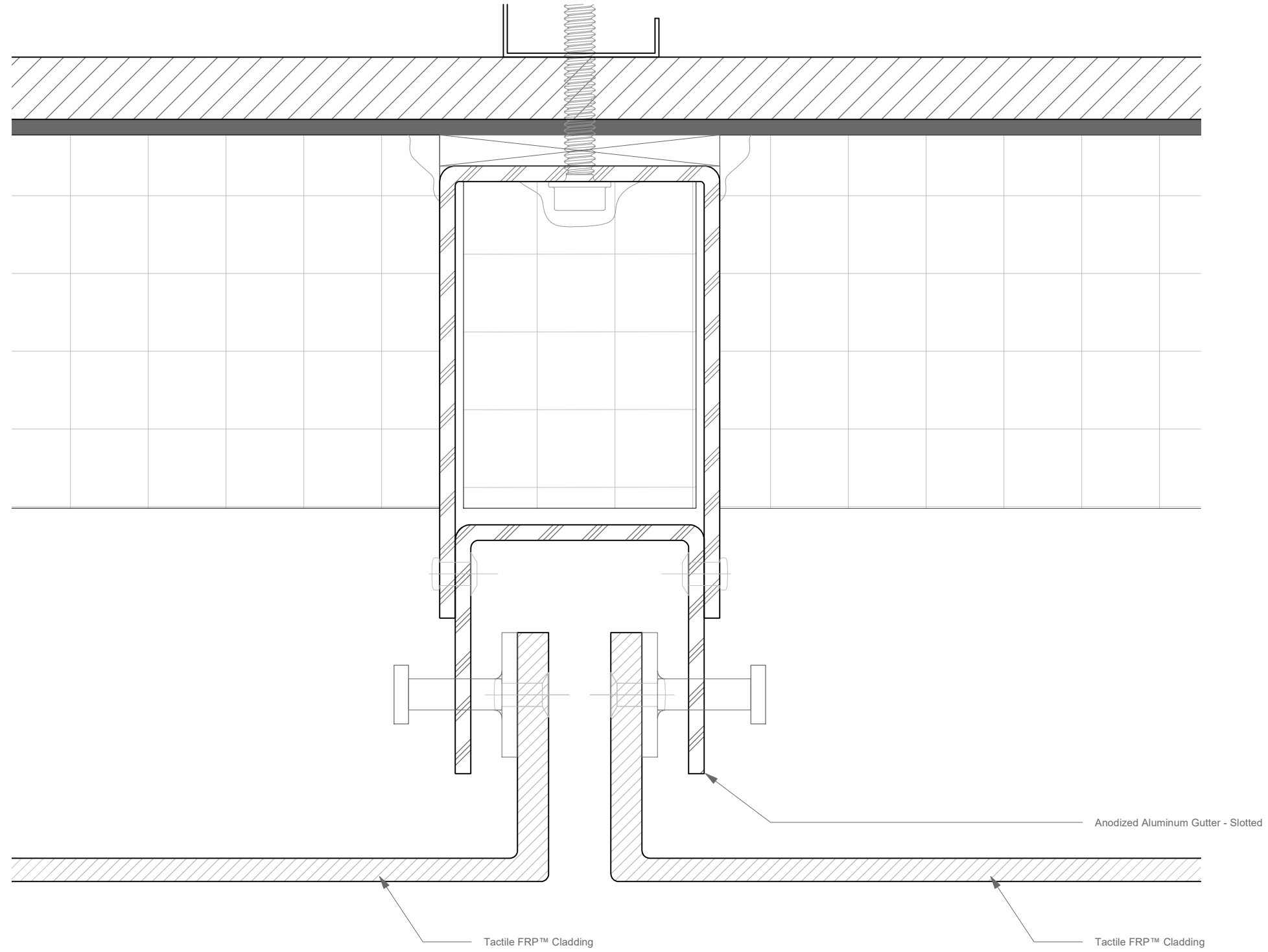

1 Plan - Typical Vertical Joint - Tactile FRP™  
 AM-01 Scale: Full Scale

SHEET NO. AM-01	REVISIONS	DATE	APPROVED
SCALE AS NOTED	DESCRIPTION		
DRAWN BY JO			
APPROVED BY SE			
ISSUE DATE 11/05/2019			

PROJECT#  
 Tactile FRP™ Cladding Details  
 Ventilated Rainscreen

CLIENT

ARCHITECT

1 Section - Typical Horizontal Joint - Tactile FRP™  
 AM-02 Scale: Full Scale

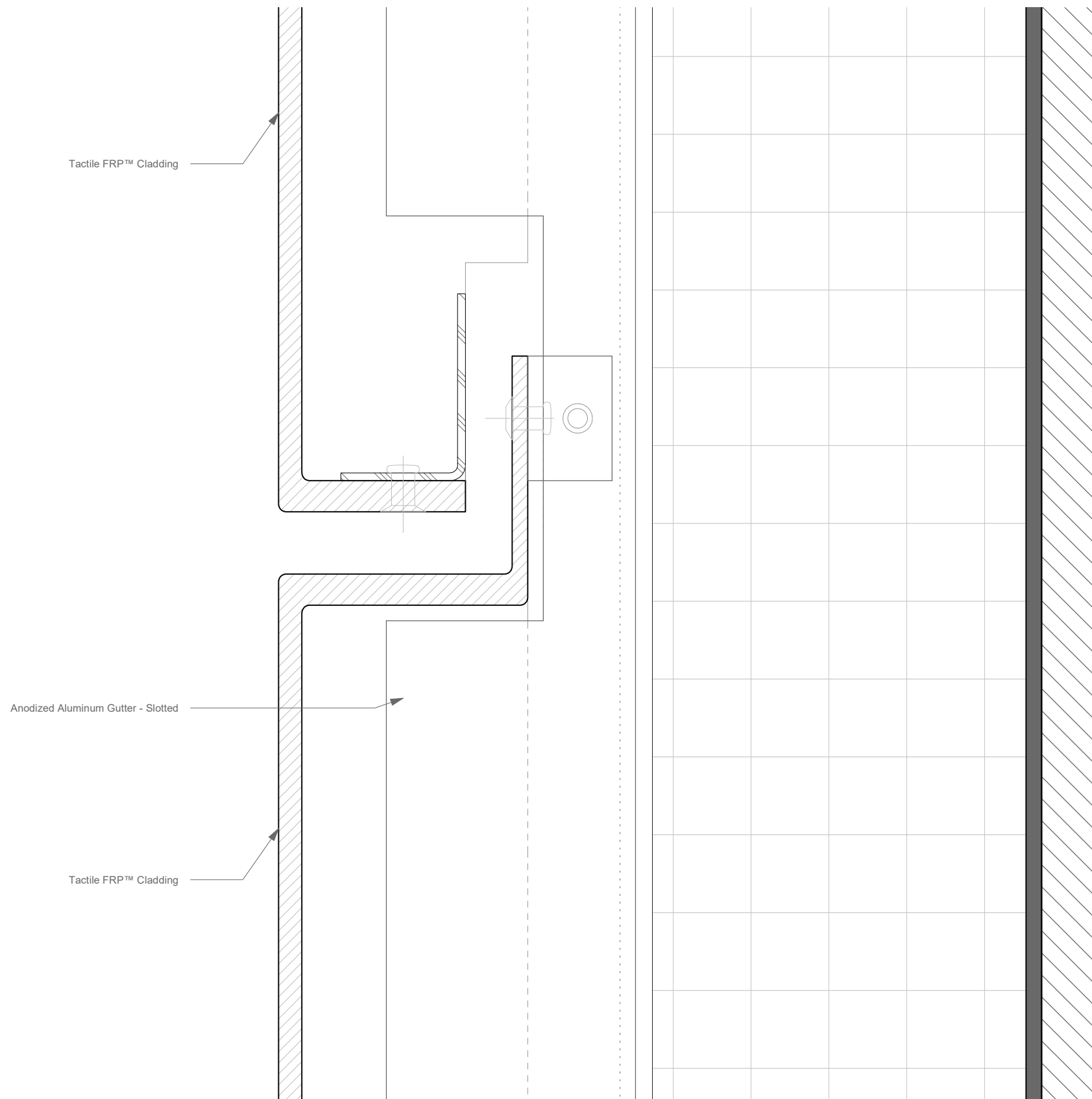

SHEET NO. AM-02	REVISIONS	DATE	APPROVED
SCALE AS NOTED	DESCRIPTION	DATE	APPROVED
DRAWN BY JO			
APPROVED BY SE			
ISSUE DATE 11/05/2019			

PROJECT#  
 Tactile FRP™ Cladding Details  
 Ventilated Rainscreen

ARCHITECT

CLIENT

1 Section - Sill Detail - Tactile FRP™  
 AM-03 Scale: Full Scale

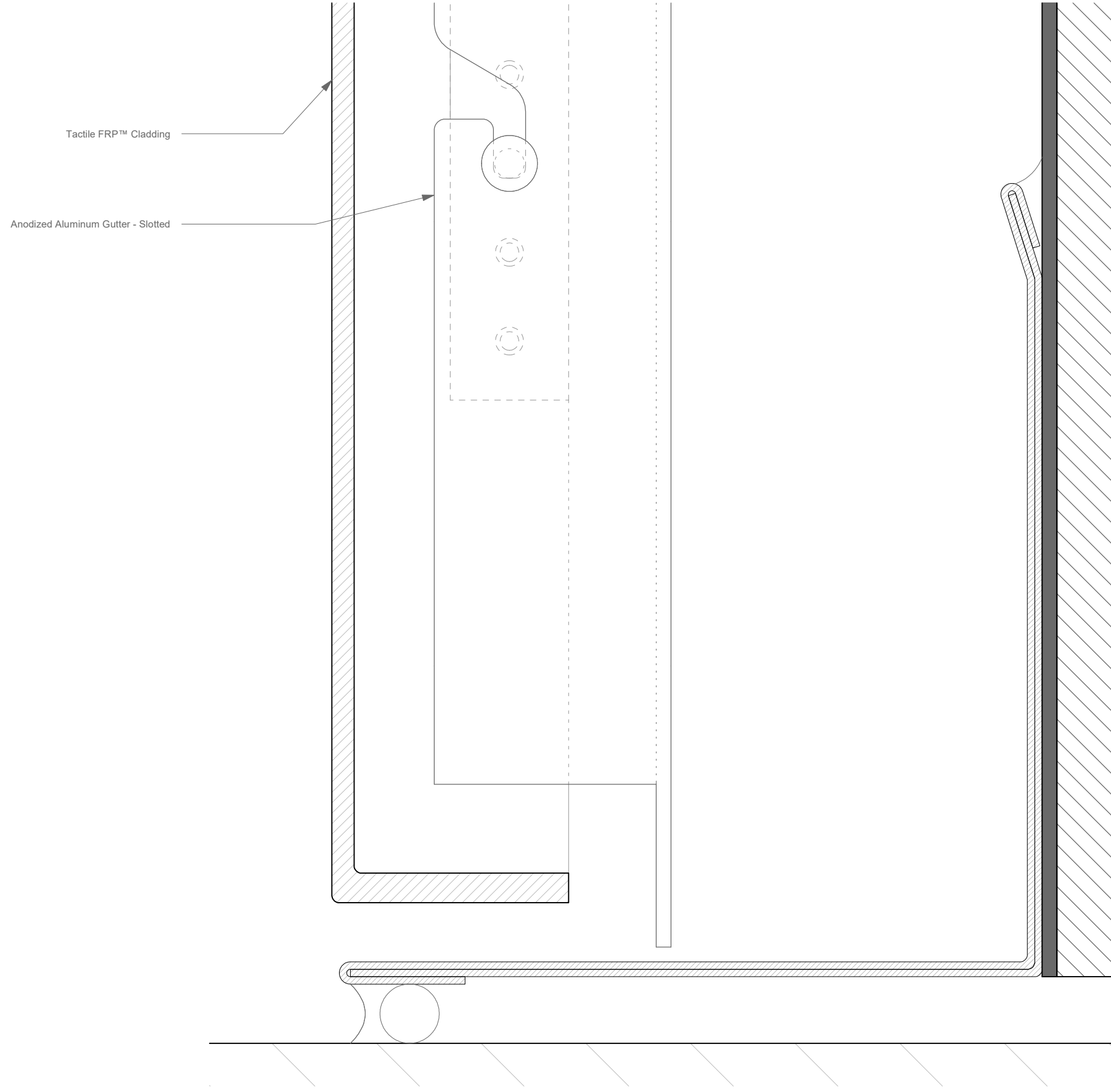

SHEET NO. AM-03		REVISIONS		DATE	APPROVED
SCALE	AS NOTED	REV	DESCRIPTION	DATE	APPROVED

PROJECT#  
 Tactile FRP™ Cladding Details  
 Ventilated Rainscreen

CLIENT

ARCHITECT

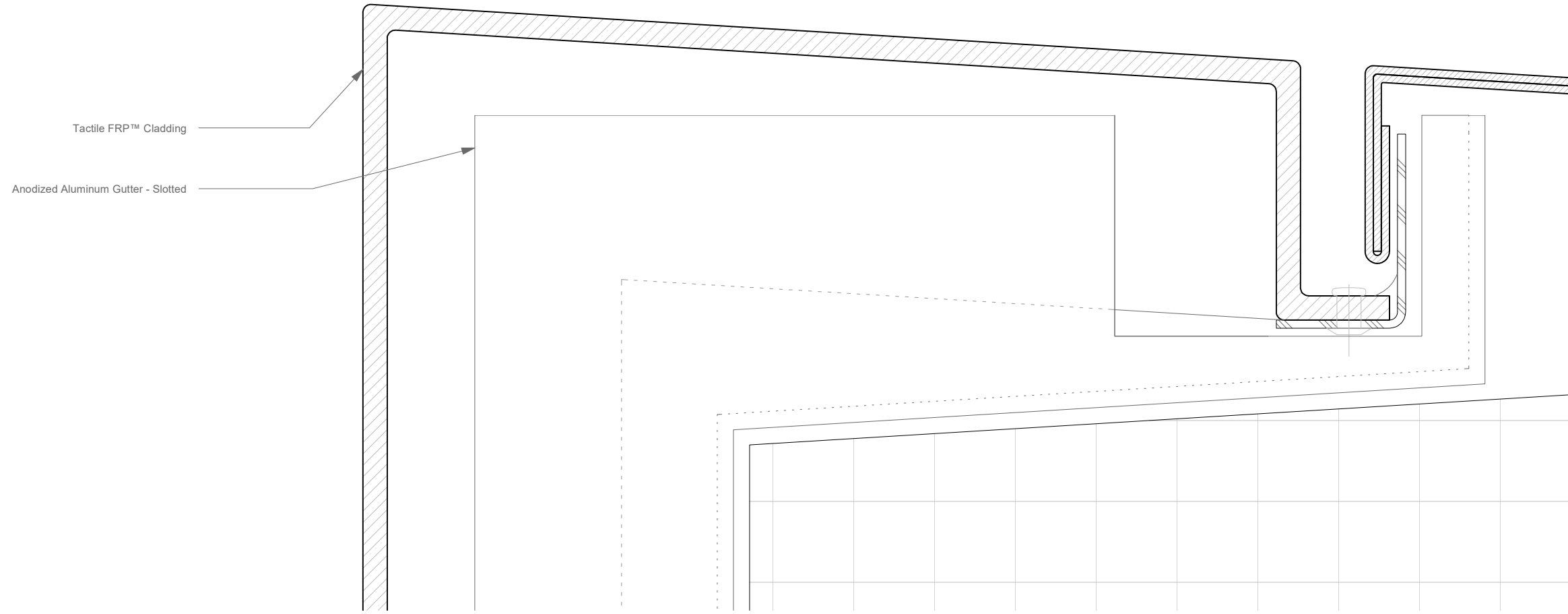

Tactile FRP™ Cladding

Anodized Aluminum Gutter - Slotted

1 Section - Parapet Return Detail - Tactile FRP™  
 AM-04 Scale: Full Scale

SHEET NO. AM-04  
 SCALE AS NOTED  
 DRAWN BY JO  
 APPROVED BY SE  
 ISSUE DATE 11/05/2019

REVISIONS		DATE	APPROVED
REV	DESCRIPTION		

PROJECT#  
 Tactile FRP™ Cladding Details  
 Ventilated Rainscreen

ARCHITECT

CLIENT

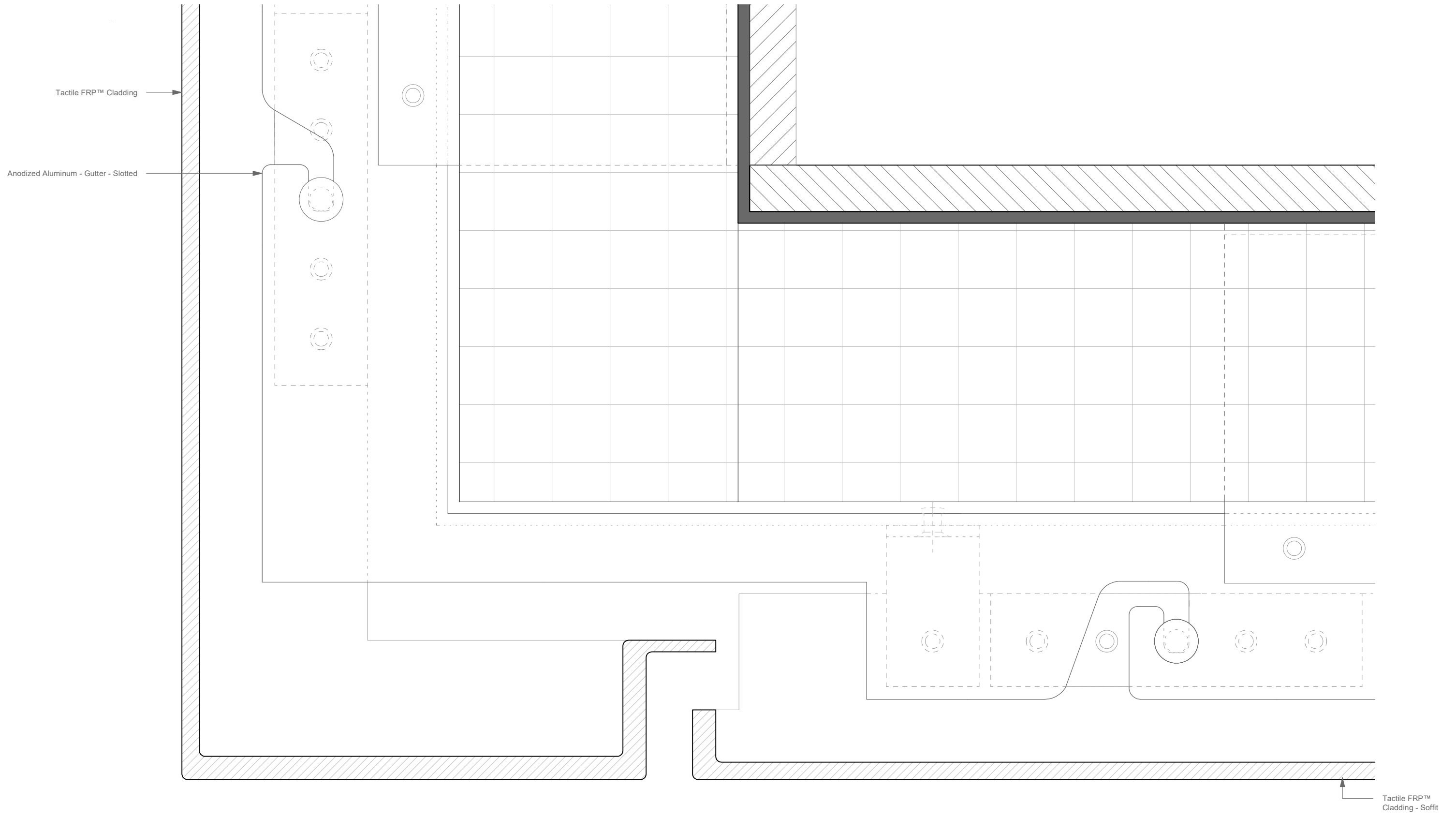

Tactile FRP™ Cladding

Anodized Aluminum - Gutter - Slotted

Tactile FRP™ Cladding - Soffit

1 Section - Typical Soffit Detail - Tactile FRP™  
 AM-05 Scale: Full Scale

CLIENT

ARCHITECT

PROJECT#

Tactile FRP™ Cladding Details  
 Ventilated Rainscreen

REVISIONS

DESCRIPTION

REV

DATE

APPROVED

APPROVED BY

ISSUE DATE

AM-05

AS NOTED

JO

SE

09/09/2019

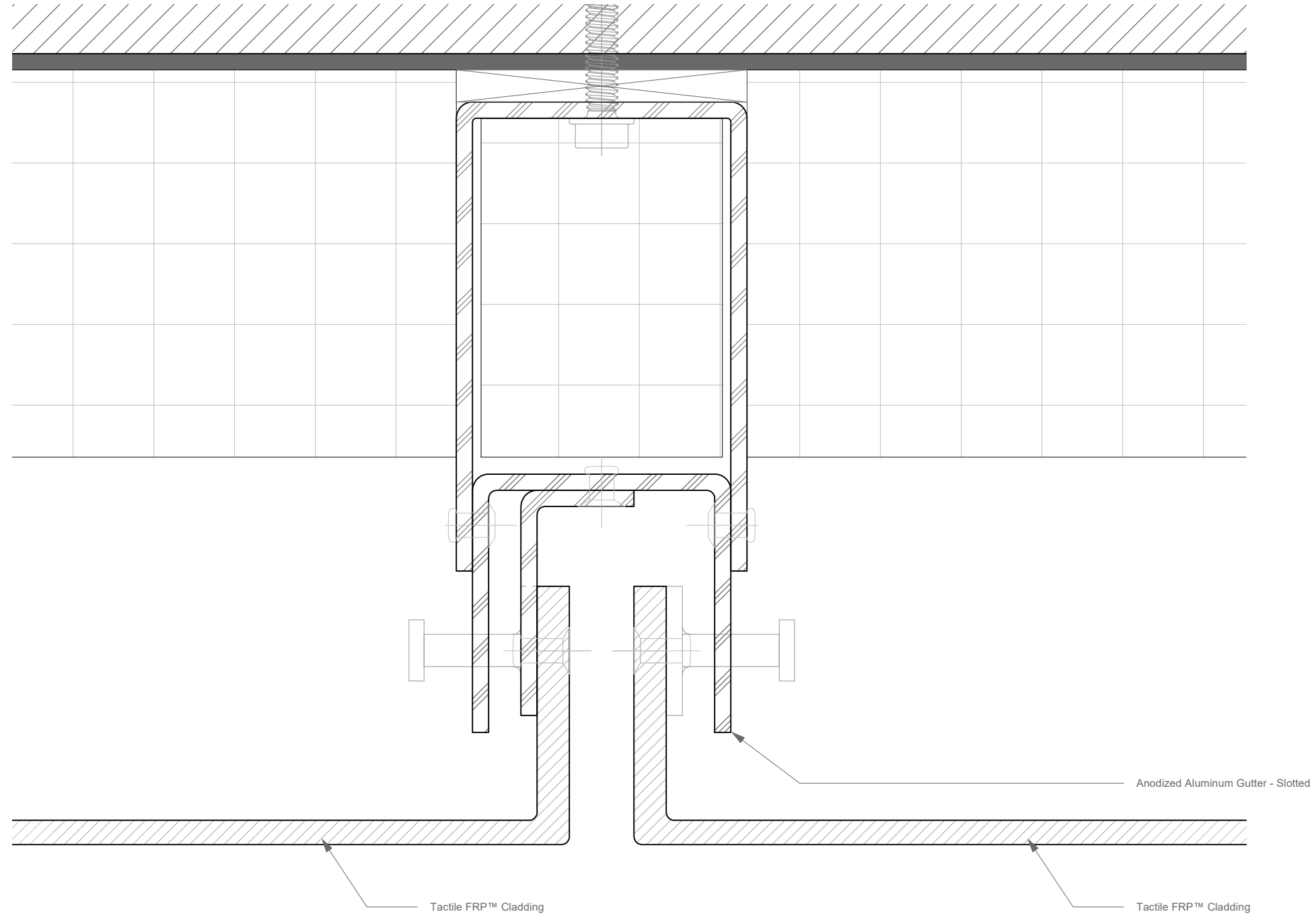

1 Plan - Typical Vertical Joint w/ Anti-Lift Clip - Tactile FRP™  
 AM-01A Scale: Full Scale

SHEET NO. AM-01A	REVISIONS	DATE	APPROVED
SCALE AS NOTED	DESCRIPTION		
DRAWN BY JO			
APPROVED BY SE			
ISSUE DATE 11/05/2019			

PROJECT#	ARCHITECT	CLIENT
Tactile FRP™ Cladding Details Ventilated Rainscreen		

1 Isometric - Detail Map - Tactile FRP™  
 AM-00 Scale: No Scale

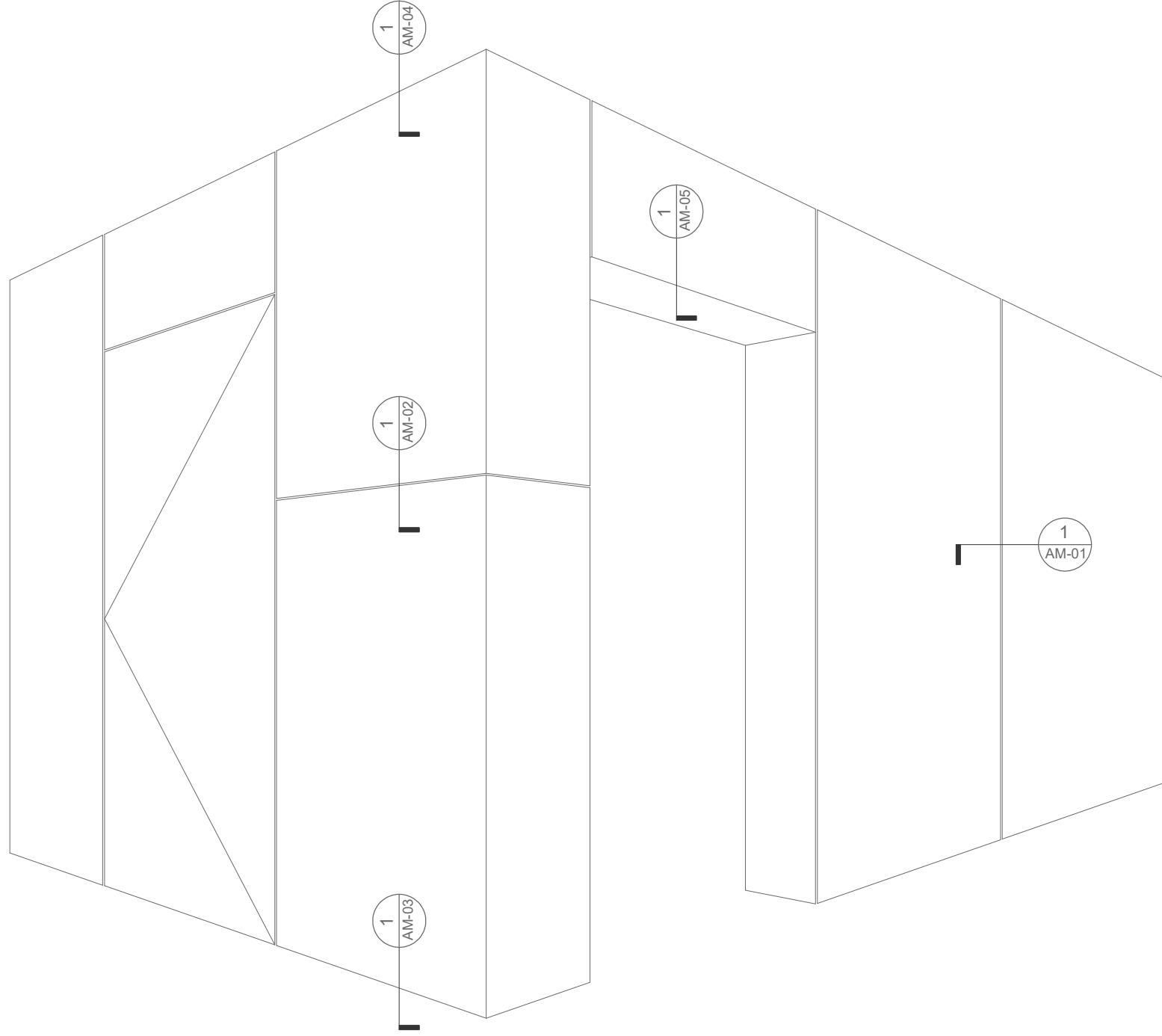

SHEET NO. AM-00  
 SCALE AS NOTED  
 DRAWN BY JO  
 APPROVED BY SE  
 ISSUE DATE 11/05/2019

REVISIONS		DATE	APPROVED
REV	DESCRIPTION		

PROJECT#  
 Tactile FRP™ Cladding Details  
 Wet-Sealed Rainscreen

ARCHITECT

CLIENT



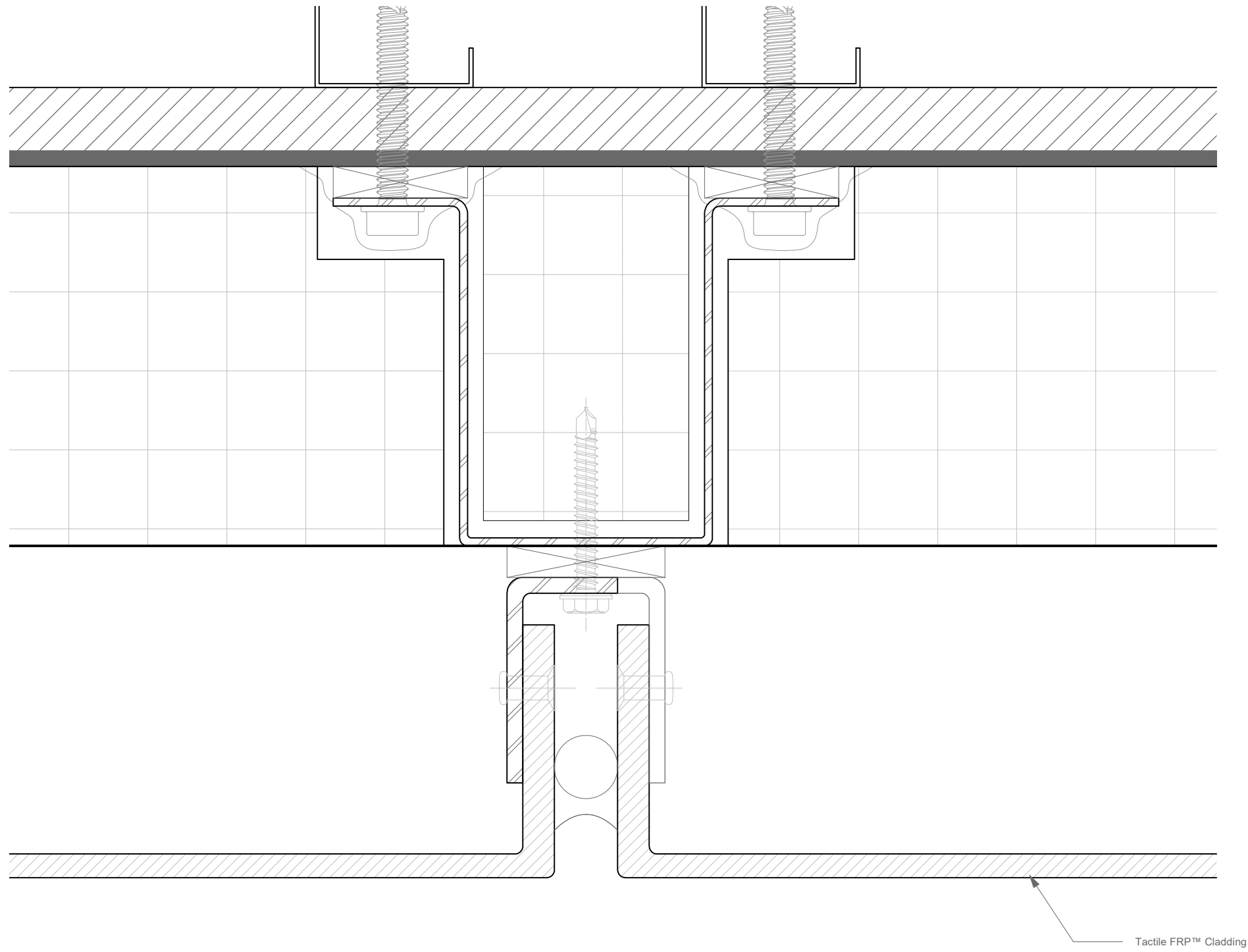

SHEET NO. AM-01	REVISIONS	DATE	APPROVED
SCALE AS NOTED	DESCRIPTION	DATE	APPROVED
DRAWN BY JO			
APPROVED BY SE			
ISSUE DATE 11/05/2019			

PROJECT#	ARCHITECT	CLIENT
Tactile FRP™ Cladding Details Wet-Sealed Rainscreen		

1 Section - Typical Horizontal Joint - Tactile FRP™  
 AM-02 Scale: Full Scale

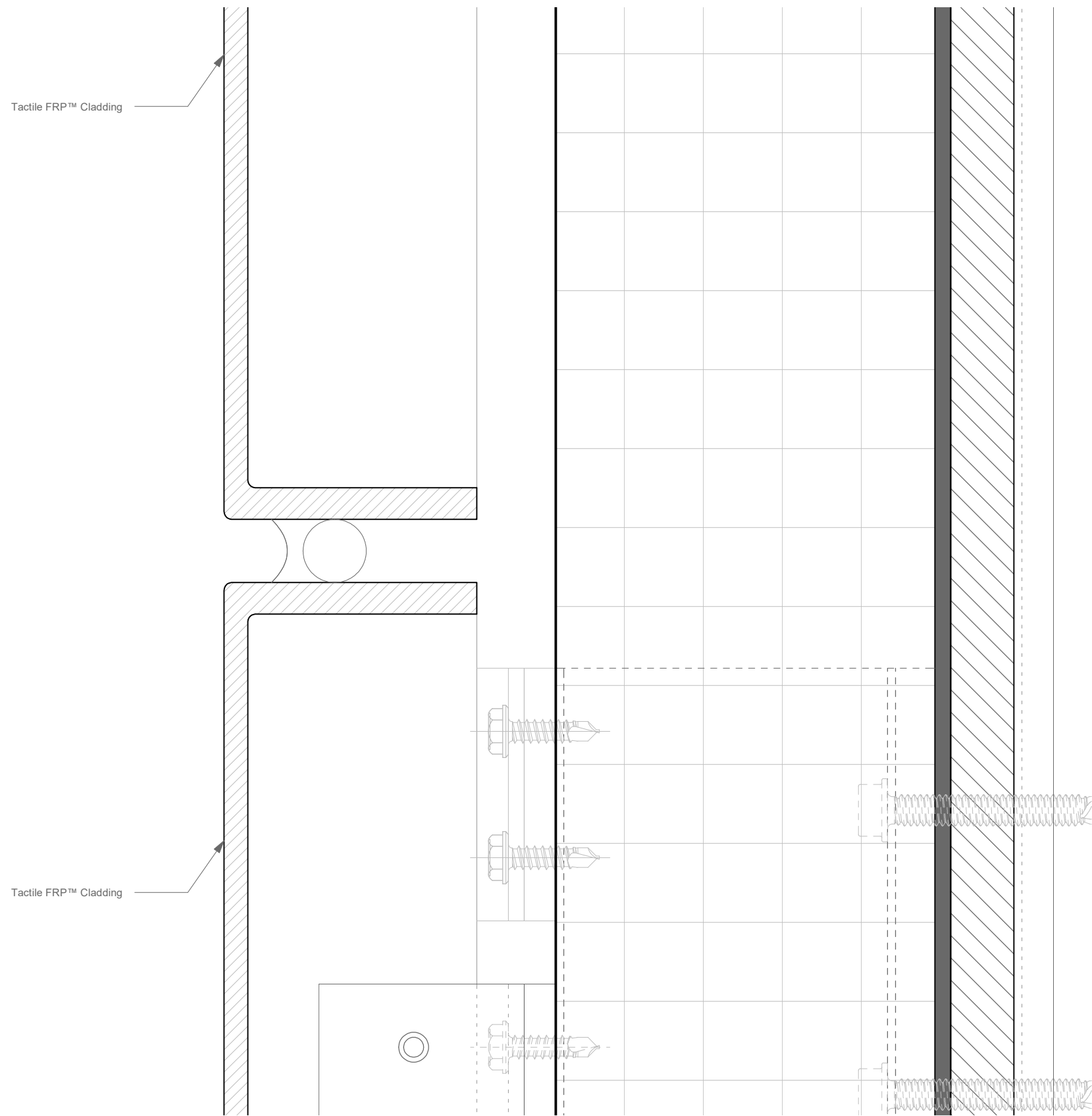

SHEET NO. AM-02	REVISIONS	DATE	APPROVED
SCALE AS NOTED	DESCRIPTION	DATE	APPROVED
DRAWN BY JO			
APPROVED BY SE			
ISSUE DATE 11/05/2019			

PROJECT#  
 Tactile FRP™ Cladding Details  
 Wet-Sealed Rainscreen

CLIENT

ARCHITECT

1 Section - Sill Detail - Tactile FRP™  
 AM-03 Scale: Full Scale

Tactile FRP™ Cladding

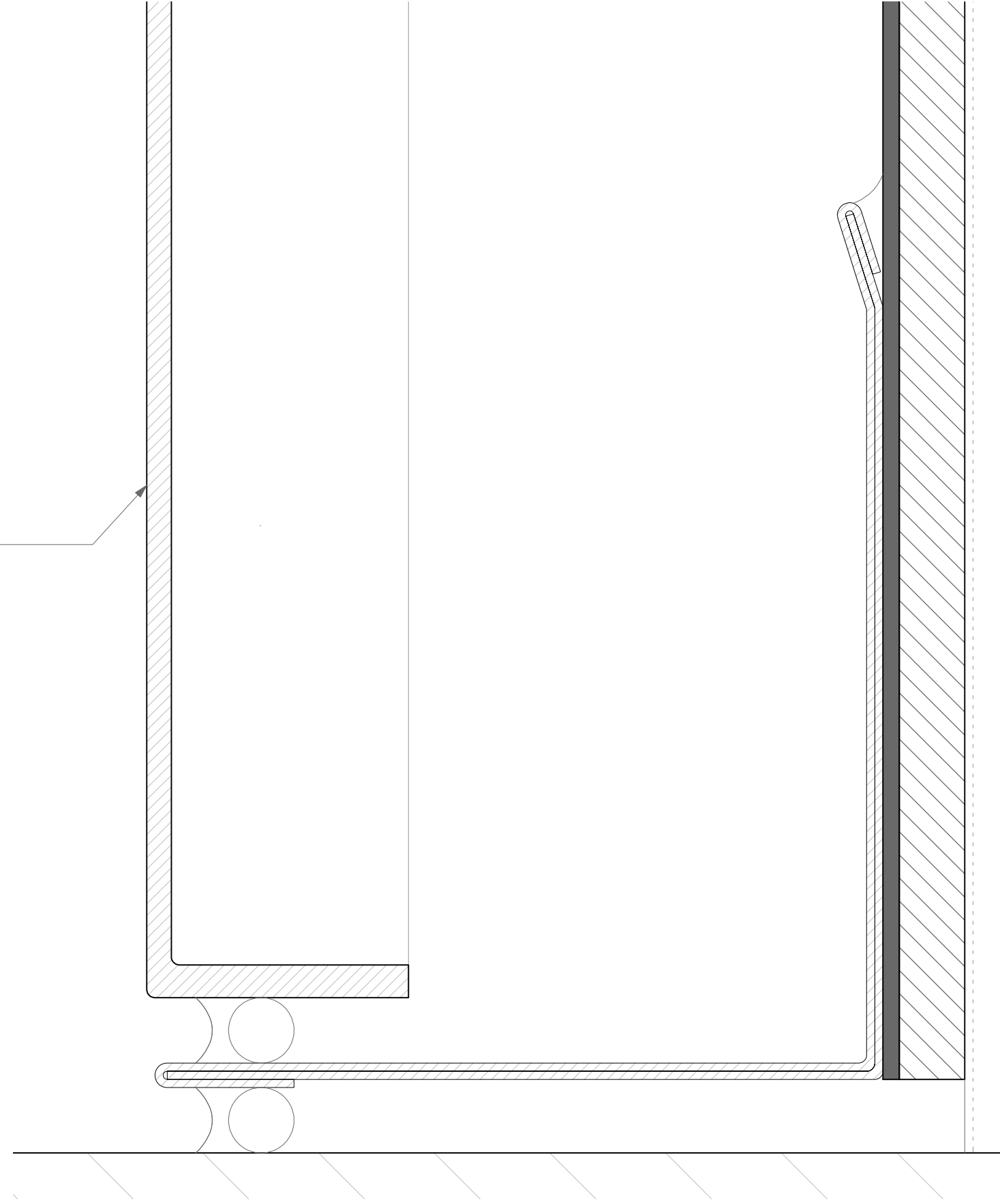

SHEET NO. AM-03	REVISIONS		DATE	APPROVED
SCALE AS NOTED	REV	DESCRIPTION	DATE	APPROVED
DRAWN BY JO				
APPROVED BY SE				
ISSUE DATE 11/05/2019				

PROJECT#  
 Tactile FRP™ Cladding Details  
 Wet-Sealed Rainscreen

CLIENT

ARCHITECT

Tactile FRP™ Cladding

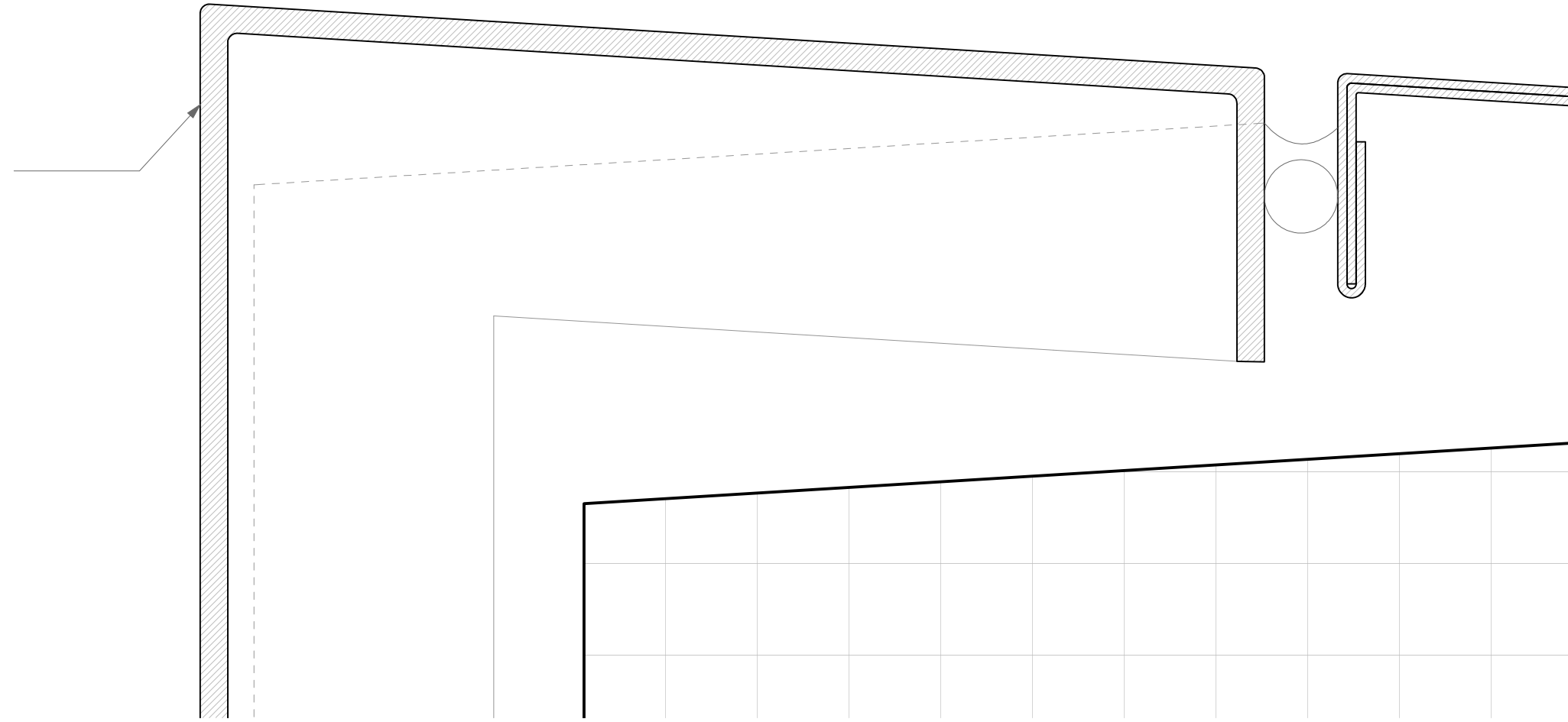

1 Section - Parapet Return Detail - Tactile FRP™  
AM-04 Scale: Full Scale

SHEET NO. AM-04  
SCALE AS NOTED  
DRAWN BY JO  
APPROVED BY SE  
ISSUE DATE 11/05/2019

REVISIONS	
REV	DESCRIPTION

DATE	APPROVED

PROJECT#  
Tactile FRP™ Cladding Details  
Wet-Sealed Rainscreen

ARCHITECT

CLIENT

Tactile FRP™ Cladding

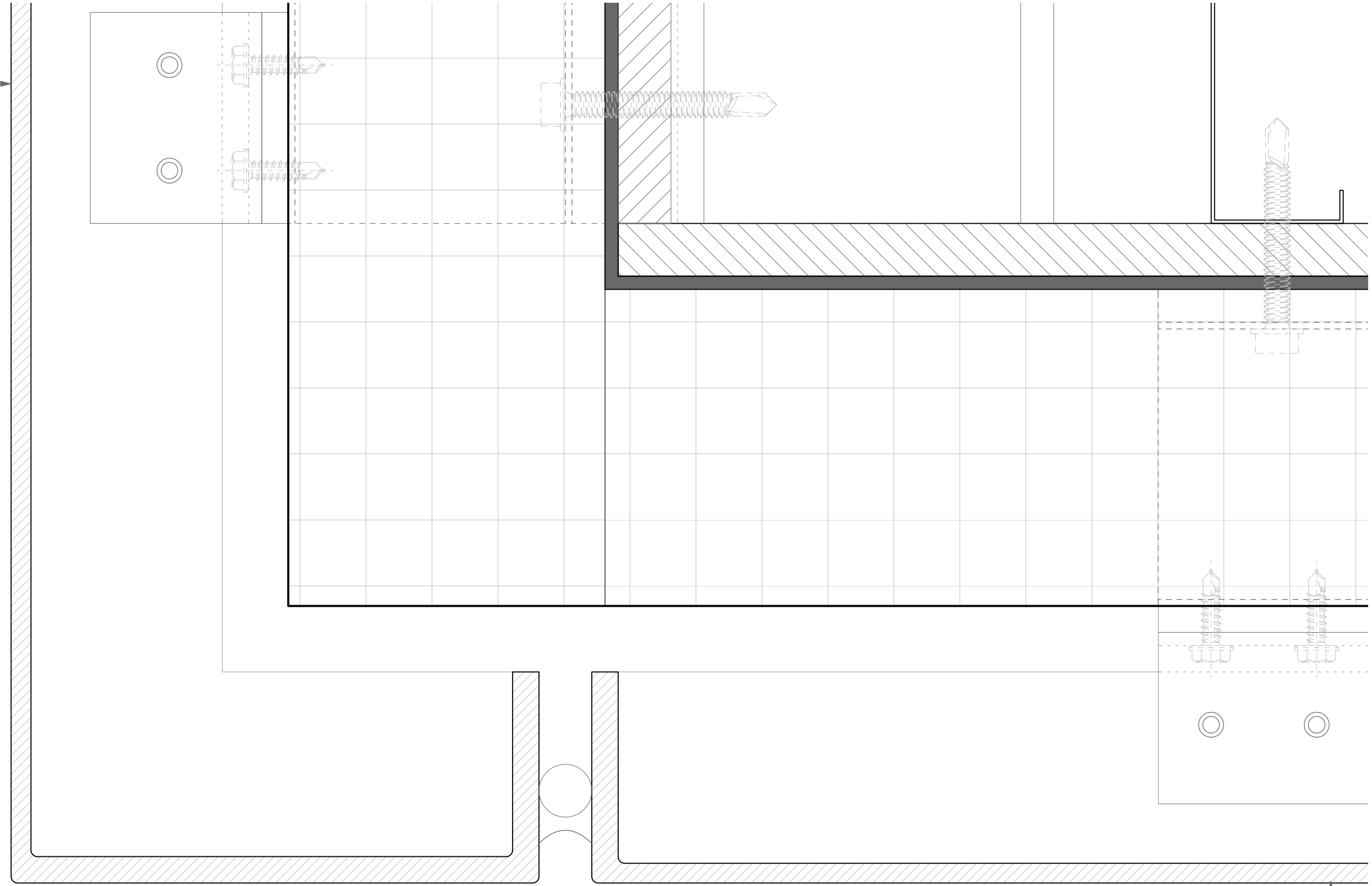

Tactile FRP™  
Cladding - Soffit

1 Section - Typical Soffit Detail - Tactile FRP™  
AM-05 Scale: Full Scale

SHEET NO. AM-05  
SCALE AS NOTED  
DRAWN BY JO  
APPROVED BY SE  
ISSUE DATE 11/05/2019

REVISIONS	
REV	DESCRIPTION

DATE	APPROVED

PROJECT#  
Tactile FRP™ Cladding Details  
Wet-Sealed Rainscreen

ARCHITECT

CLIENT

**architectural**  
**materials**  
materials for inspired architecture™  
www.architecturalmaterials.com

1 Isometric - Detail Map - Tactile FRP™  
 AM-00 Scale: No Scale

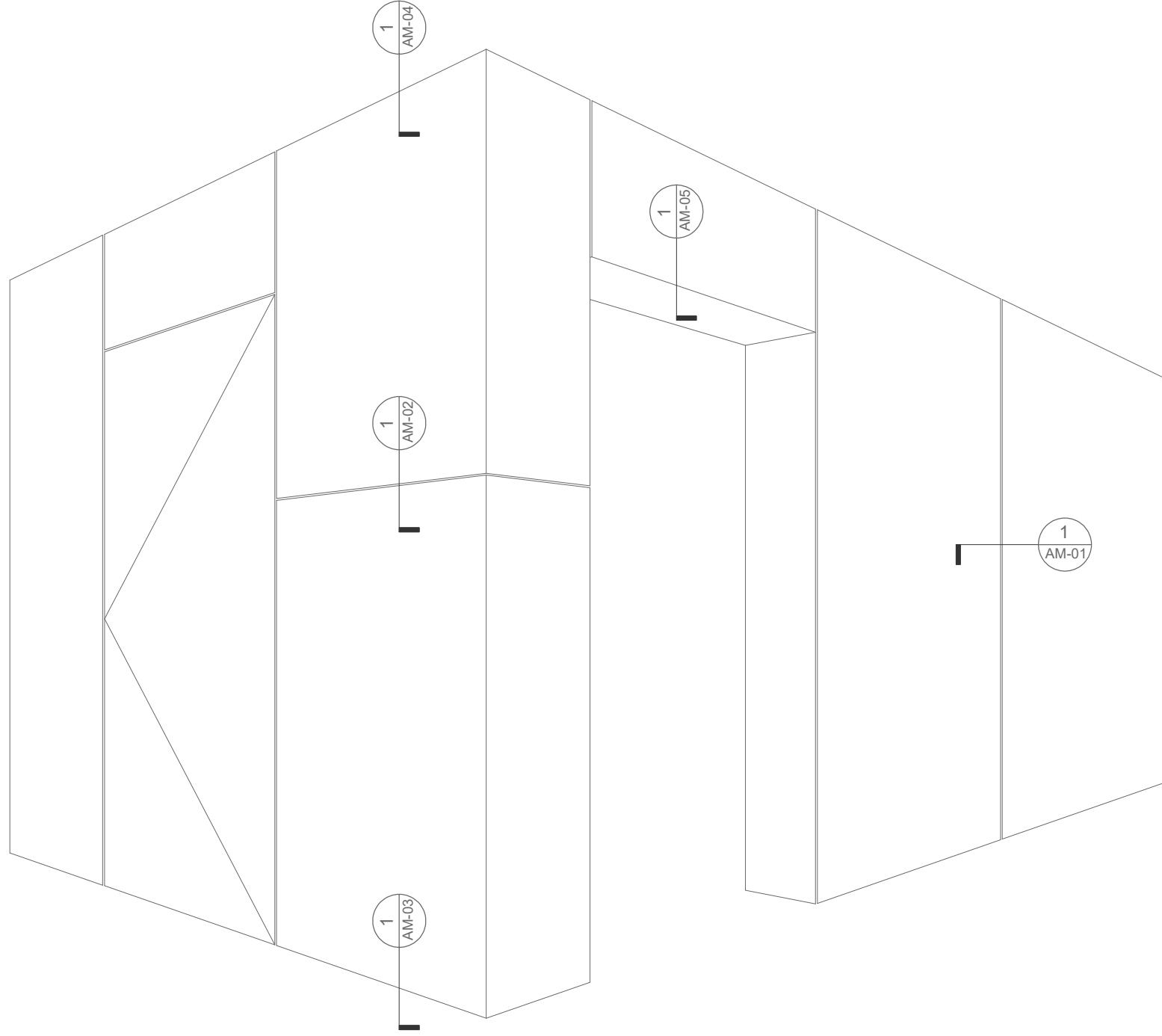

SHEET NO. AM-00	REVISIONS	PROJECT#	ARCHITECT	CLIENT
SCALE AS NOTED	DESCRIPTION	Tactile FRP™ Cladding Details Interior Cladding		
DRAWN BY JO	DATE			
APPROVED BY SE	APPROVED			
ISSUE DATE 11/05/2019				

**architectural**  
**materials**  
 materials for inspired architecture™  
 www.architecturalmaterials.com

1 Plan - Typical Vertical Joint - Tactile FRP™  
 AM-01 Scale: Full Scale

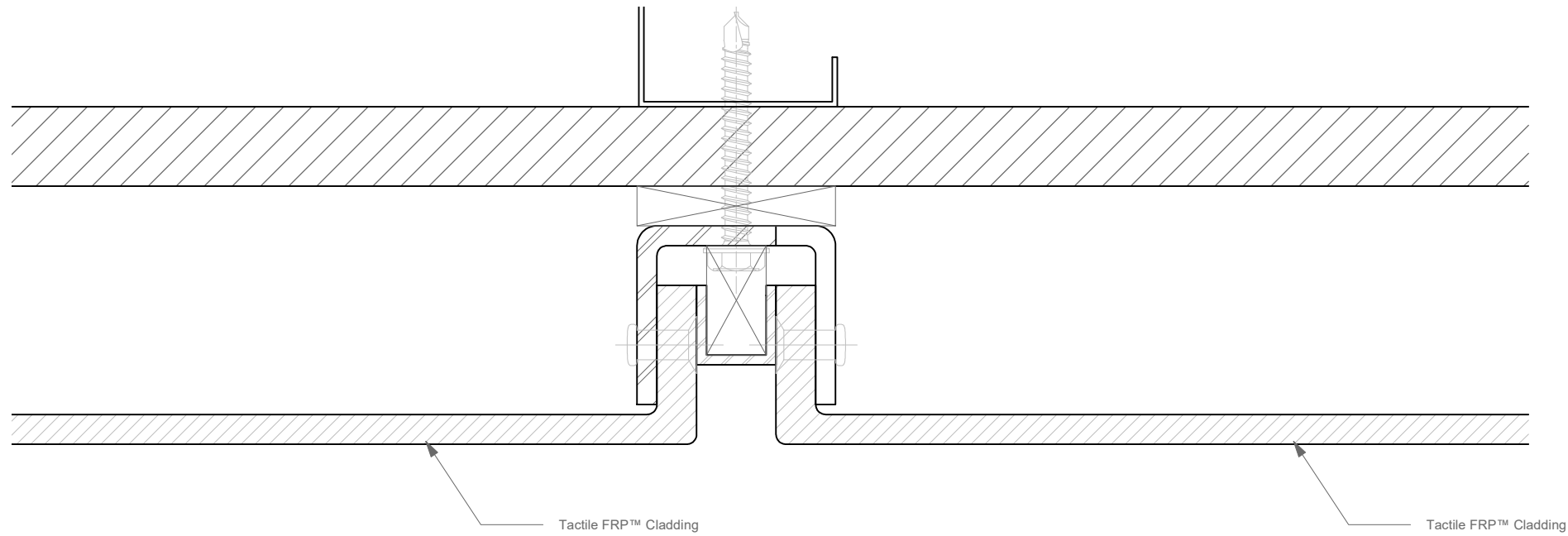

SHEET NO. AM-01  
 SCALE AS NOTED  
 DRAWN BY JO  
 APPROVED BY SE  
 ISSUE DATE 11/05/2019

REVISIONS		DATE	APPROVED
REV	DESCRIPTION		

PROJECT#  
 Tactile FRP™ Cladding Details  
 Interior Cladding

ARCHITECT

CLIENT

1 Section - Typical Horizontal Joint - Tactile FRP™  
 AM-02 Scale: Full Scale

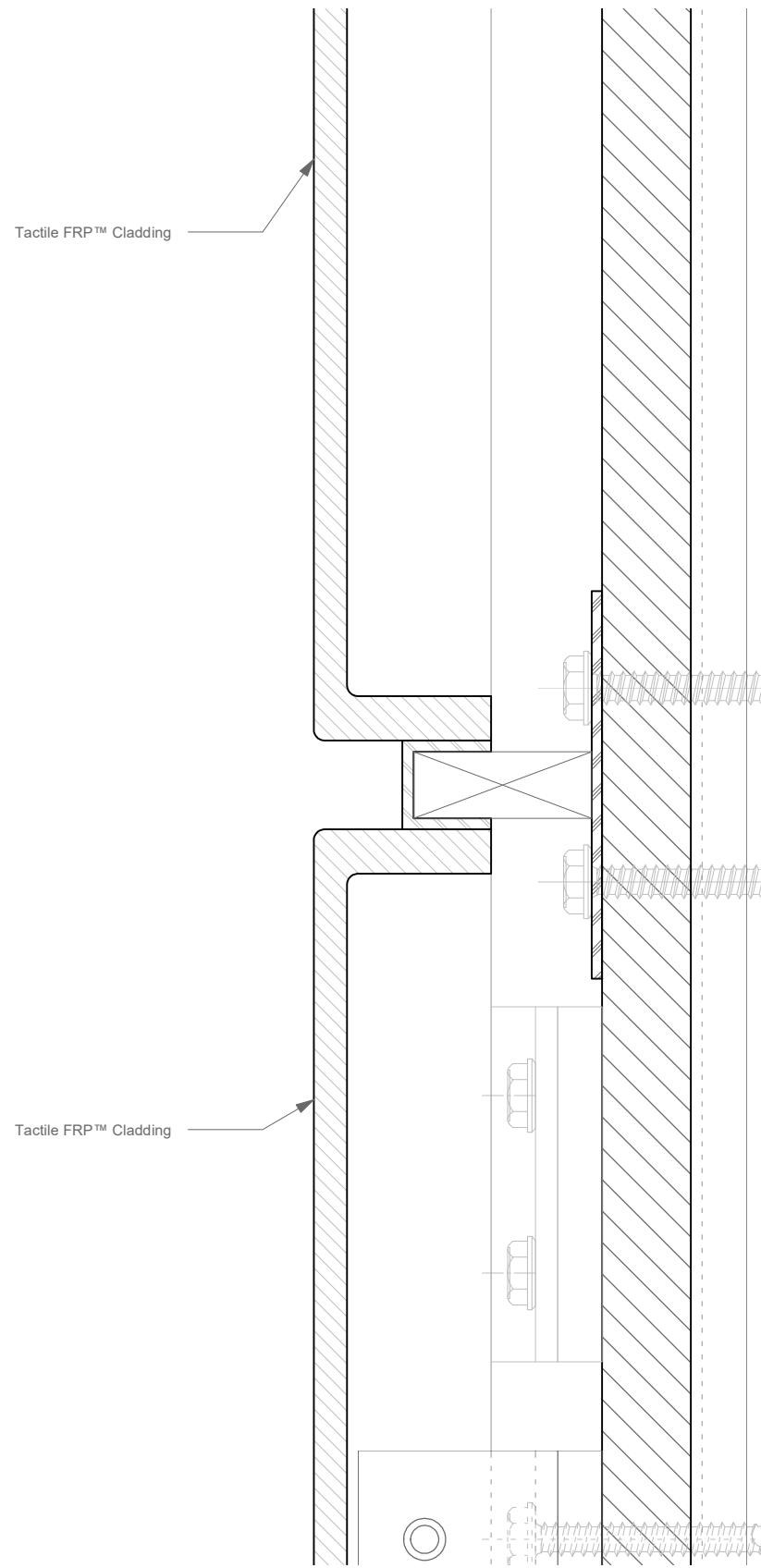

SHEET NO. AM-02	REVISIONS	PROJECT#	ARCHITECT	CLIENT
SCALE AS NOTED	DESCRIPTION	Tactile FRP™ Cladding Details Interior Cladding		
DRAWN BY JO	DATE			
APPROVED BY SE	APPROVED			
ISSUE DATE 11/05/2019				



1 Section - Typical Horizontal Joint at Ground - Tactile FRP™  
 AM-03 Scale: Full Scale

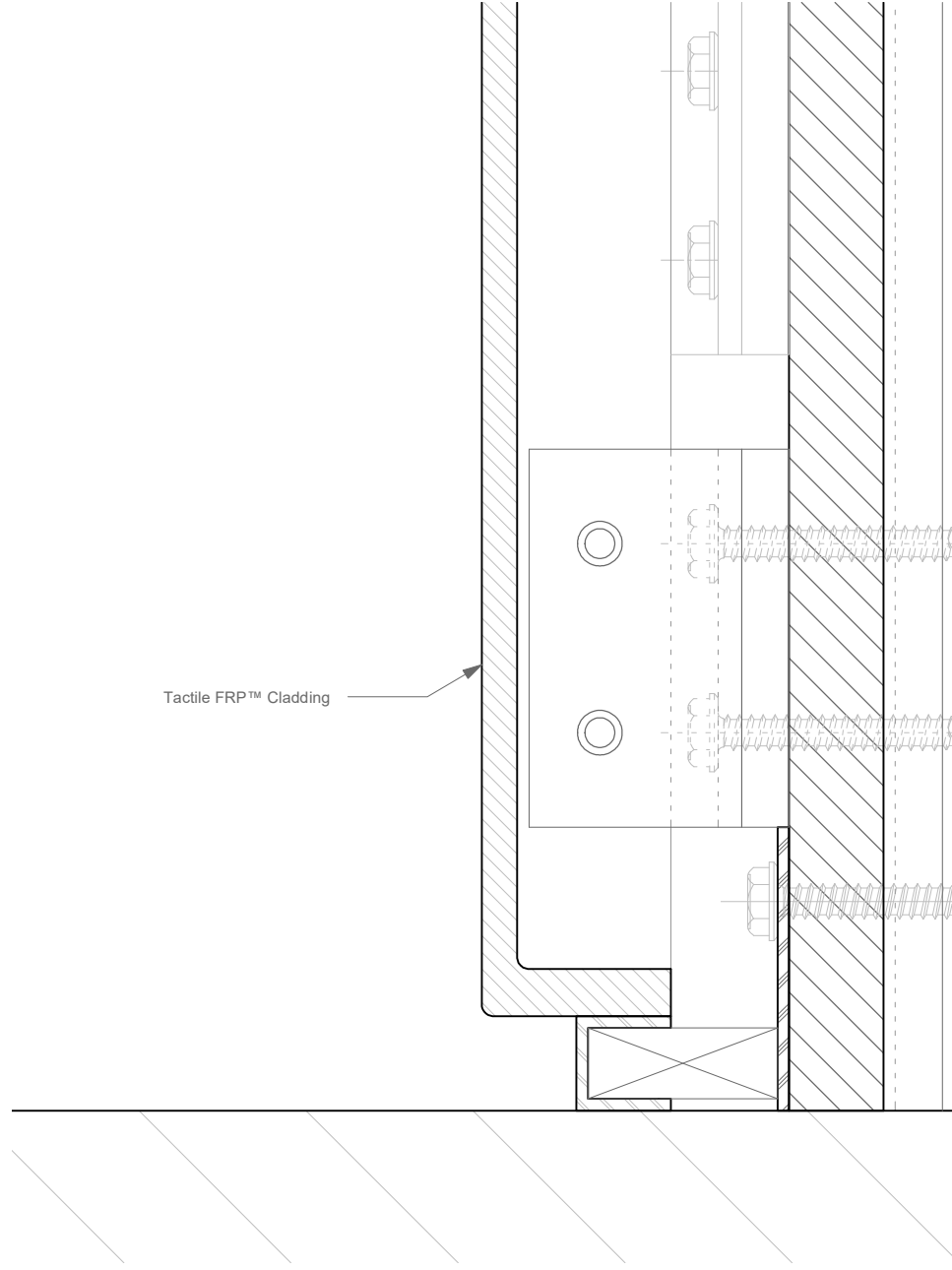

SHEET NO. AM-03		REVISIONS		PROJECT#		ARCHITECT		CLIENT	
SCALE	AS NOTED	REV	DESCRIPTION	DATE	APPROVED				

Tactile FRP™ Cladding Details  
 Interior Cladding

1 Section - Typical Horizontal Joint at Ceiling - Tactile FRP™  
 AM-04 Scale: Full Scale

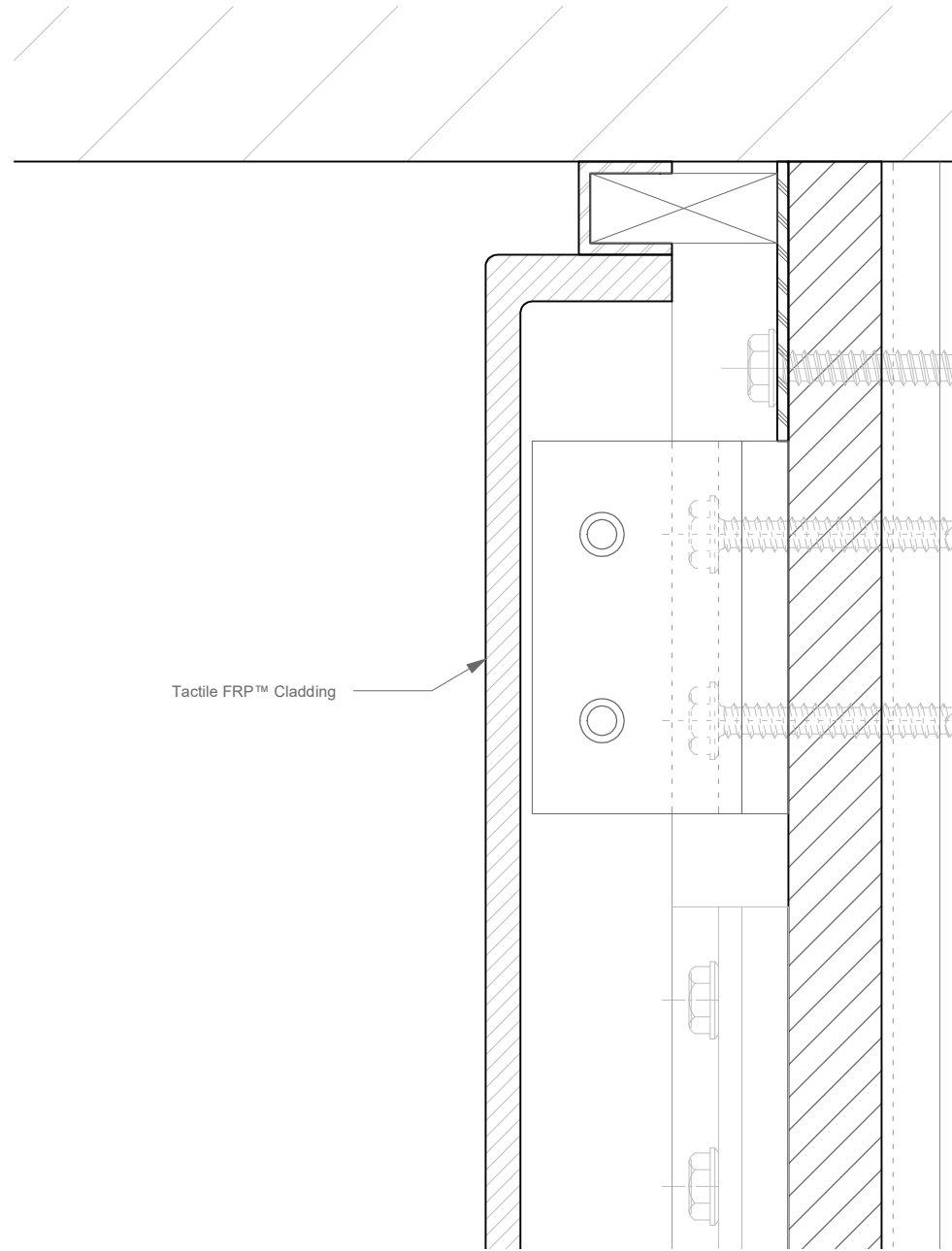

SHEET NO. AM-04	REVISIONS			PROJECT#	ARCHITECT	CLIENT
SCALE AS NOTED	REV	DESCRIPTION	DATE	Tactile FRP™ Cladding Details Interior Cladding		
DRAWN BY JO						
APPROVED BY SE						
ISSUE DATE 11/05/2019						